



Bâtiments scolaires



Logements collectifs



Parcs Jardins publics



- + Design moderne et solide
- + Barreaux tube rectangulaires 50 x 10 mm en applique
- + Pose facile
- + Portail et portillon assortis

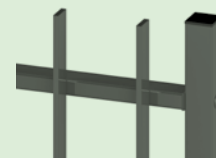

Barreaux	Tube rect. 50 x 10 mm
Lisse horizontale	50 x 30 mm
Entraxe poteaux	2 500 mm



CORDONNÉS DISPONIBLES

→ Portail
→ Portillon

ESTHÉTIQUE ET RÉSISTANT

- ✓ Design tendance
- ✓ Modernité et plus-value à l'habitat
- ✓ Multi-application : résidentiel, industriel, lieux publics (école, lycée, mairie...)
- ✓ Sécurité et durabilité élevée

TRAITEMENT DE SURFACE

- ✓ Plastification haute adhérence par poudrage polyester sur acier Sendzimir® 275 g/m² selon la norme NF.



Vert
RAL 6005



Noir
RAL 9005



Gris
RAL 7016

TENUE TEINTE
ANTI-CORROSION
GARANTIE*
10 ans

Autres couleurs sur demande



* Conditions de garantie : nous contacter

POSE FACILE

- ✓ Simple emboîtement des lisses aux poteaux carrés
- ✓ Pose sur platine ou en scellement
- ✓ Angles et redans aisés
- ✓ 2 types de poteaux :



POTEAU ROND



POTEAU CARRÉ

• Correspondances dimensions barreaudages / poteaux

Hauteur barreaudage	Hauteur poteaux à sceller	Hauteur poteaux sur platine
0,95 m	1,40 m	1 m
1,25 m	1,60 m	1,30 m
1,45 m	2 m	1,50 m
1,70 m	2,20 m	1,75 m
1,95 m	2,50 m	2 m
2,45 m	3 m	2,50 m

CONFORMITÉ





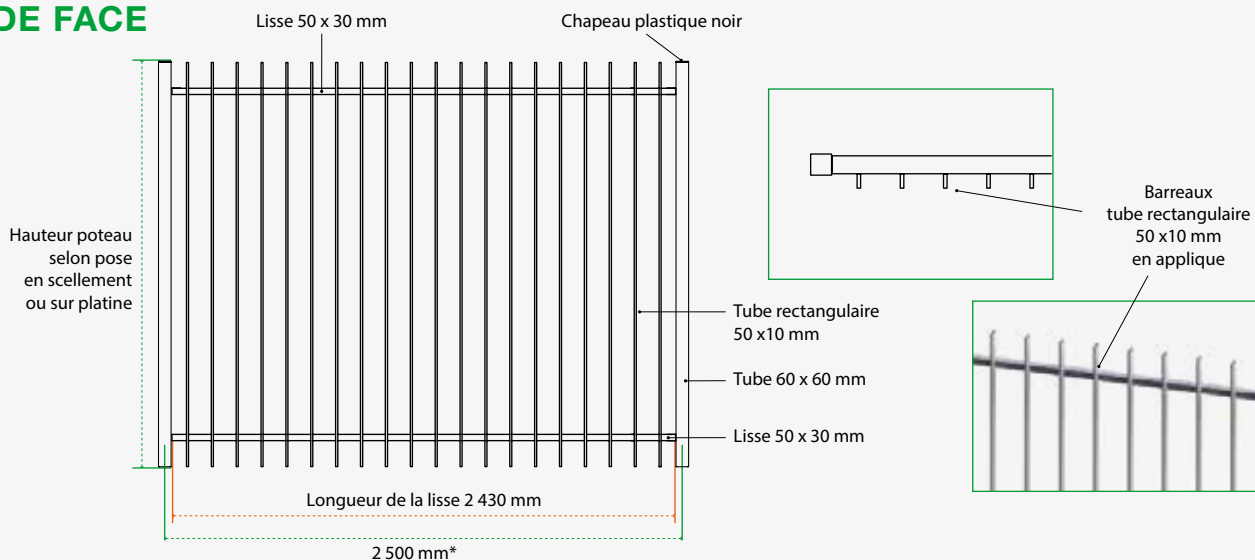

- ✓ Écartement entre barreaux 110 mm

Attention, ce n'est pas un garde corps.

VUES DE FACE

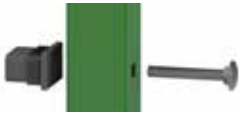

DESCRIPTIF TECHNIQUE

Montage	20 barreaux		
Matière	Acier Sendzimir® 275 g/m²		
Revêtement	Plastification haute adhérence par poudrage polyester selon la norme NF		
Barreaux	Tube rectangulaire 50 x 10 mm		
Écartement	110 mm		
Entraxe poteau	2 500 mm		
Hauteurs	1 - 1,20 - 1,50 - 1,75 - 2 - 2,50 m		
Lisse horizontale	50 x 30 mm	40 x 40 mm	
Chapeau	Plastique noir		
Ancrage poteau	À sceller ou sur platine		
Poteaux	POTEAU CARRÉ 60 x 60 mm 	POTEAU ROND Ø 60 mm 	
Fixations	Fixation plastique noir E Lisses 50 x 30 et 40 x 40 mm * Entraxe P. 2 500 mm 	Fixation avec U soudés E Lisse 50 x 30 mm * Entraxe P. 2 490 mm poteau de départ poteau intermédiaire poteau d'angle 	Fixation avec collier E Lisse 40 x 40 mm * Entraxe P. 2 510 à 2 520 mm 
	✓ Économique ✓ Discret	✓ Esthétique ✓ Poteau dédié à chaque usage	✓ Économique ✓ Fixation unique pour pose en redans et angles
Pose en redans	✓ Poteau à repercer	✓ Pièce en option U INVISIBLE 	✓ Possible
Pose en angle	✓ Poteau à doubler	✓ Poteau d'angle	✓ Possible

Photos et informations sous réserve d'évolutions techniques

OPTIONS

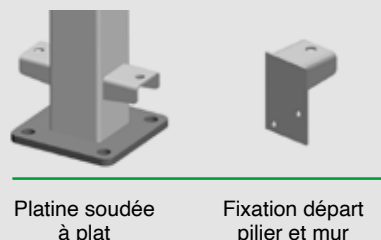

SUR-MESURE

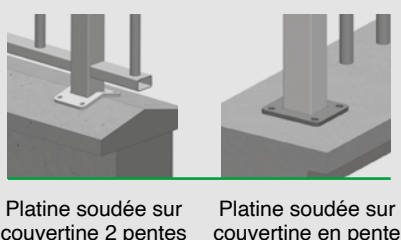

 Demandez conseil lors du devis.